

**PLL AUDIO CLOCK SYNTHESIZER**
**MK2703B**
**Description**

The MK2703B is a low-cost, low-jitter, high performance PLL clock synthesizer designed to replace oscillators and PLL circuits in set-top box and multimedia systems. Using ICS' patented analog Phase Locked Loop (PLL) techniques, the device uses a 27 MHz crystal or clock input to produce a buffered reference clock and a selectable audio clock.

ICS manufactures the largest variety of Set-Top Box and multimedia clock synthesizers for all applications. Consult ICS to eliminate VCXOs, crystals and oscillators from your board.

**Features**

- Packaged in 8-pin SOIC
- Available in RoHS compliant package
- Uses an inexpensive, fundamental mode crystal or clock
- Patented zero ppm synthesis error in all clocks
- All frequencies are frequency locked
- Advanced, low power, sub-micron CMOS process
- Operating voltage of 3.3 V or 5 V
- Industrial temperature version available

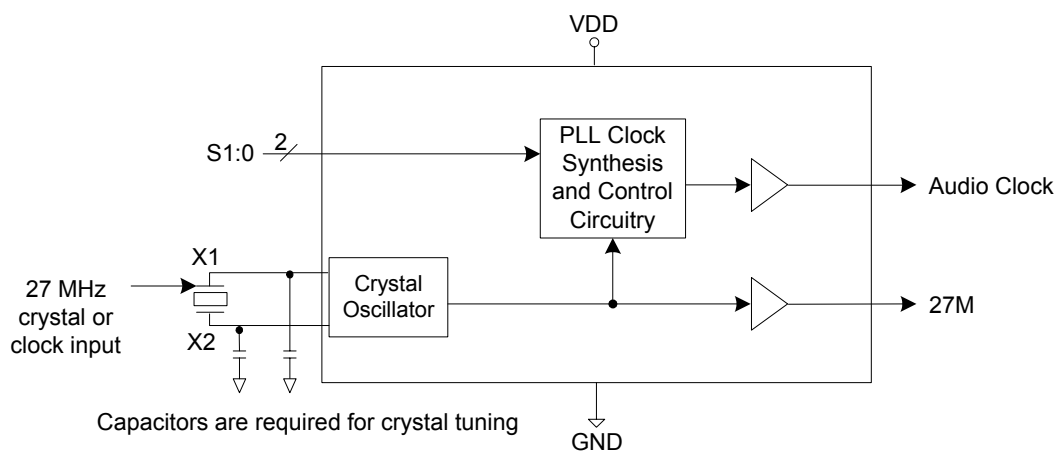
**Block Diagram**

## Pin Assignment

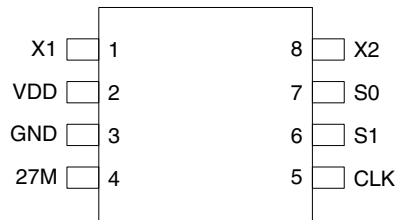

8-pin (150 mil) SOIC

## AUDIO CLOCK OUTPUT SELECT TABLE

S1	S0	CLK (MHz)
0	0	8.192
0	1	11.2896
1	0	12.288
1	1	24.576

Key: 0 = Connect pin directly to ground

1 = Connect pin directly to VDD

## Pin Descriptions

Pin Number	Pin Name	Pin Type	Pin Description
1	X1	XI	Crystal Connection. Connect to a 27 MHz fundamental crystal or clock.
2	VDD	Power	Connect to +3.3 V or +5 V.
3	GND	Power	Connect to ground.
4	27M	Output	27 MHz buffered reference clock output.
5	CLK	Output	Audio clock output per table above.
6	S1	Input	Audio clock frequency select input #1. Determines CLK output per table above. Internal pull-up resistor.
7	S0	Input	Audio clock frequency select input #0. Determines CLK output per table above. Internal pull-up resistor.
8	X2	XO	Crystal connection to a 27 MHz crystal, or leave unconnected for clock output.

## External Components

### Decoupling Capacitor

As with any high-performance mixed-signal IC, the MK2703B must be isolated from system power supply noise to perform optimally.

A decoupling capacitor of 0.01 $\mu$ F must be connected between VDD and GND on pins 2 and 3. It must be connected close to the MK2703B to minimize lead inductance. No external power supply filtering is required for the MK2703B.

### Series Termination Resistor

A 33 $\Omega$  terminating resistor can be used next to the clock outputs for trace lengths over one inch.

### Crystal Load Capacitors

The total on-chip capacitance is approximately 16 pF. A parallel resonant, fundamental mode, AT cut 27 MHz crystal should be used. The device crystal connections should include pads for small capacitors from X1 to ground and from X2 to ground. These capacitors are used to adjust the

stray capacitance of the board to match the nominally required crystal load capacitance. Because load capacitance can only be increased in this trimming process, it is important to keep stray capacitance to a minimum by using very short PCB traces (and no vias) between the crystal and device. Crystal capacitors, if needed, must be

connected from each of the pins X1 and X2 to ground.

The value (in pF) of these crystal caps should equal  $(C_L - 16 \text{ pF}) * 2$ . In this equation,  $C_L$  = crystal load capacitance in pF. Example: For a crystal with an 18 pF load capacitance, each crystal capacitor would be 4 pF  $[(18 - 16) * 2] = 4$ .

## Absolute Maximum Ratings

Stresses above the ratings listed below can cause permanent damage to the MK2703B. These ratings, which are standard values for ICS commercially rated parts, are stress ratings only. Functional operation of the device at these or any other conditions above those indicated in the operational sections of the specifications is not implied. Exposure to absolute maximum rating conditions for extended periods can affect product reliability. Electrical parameters are guaranteed only over the recommended operating temperature range.

Item	Rating
Supply Voltage, VDD	-0.5 V to 7 V
All Inputs and Outputs	-0.5 V to VDD+0.5 V
Ambient Operating Temperature, MK2703BS (commercial)	0 to +70°C
Ambient Operating Temperature, MK2703BSI (industrial)	-40 to +85°C
Storage Temperature	-65 to +150°C
Soldering Temperature	260°C

## Recommended Operation Conditions

Parameter	Min.	Typ.	Max.	Units
Ambient Operating Temperature	-40		+85	°C
Power Supply Voltage (measured in respect to GND)	+3.13		+5.50	V

## DC Electrical Characteristics

VDD=3.3 V ±5% , Ambient temperature -40 to +85°C, unless stated otherwise

Parameter	Symbol	Conditions	Min.	Typ.	Max.	Units
Operating Voltage	VDD		3.13		5.50	V
Input High Voltage	V <sub>IH</sub>	X1 pin only Note 1	(VDD/2)+1	VDD/2		V
Input Low Voltage	V <sub>IL</sub>	X1 pin only Note 1		VDD/2	(VDD/2)-1	V
Input High Voltage	V <sub>IH</sub>	S0, S1 pins	2.0			V
Input Low Voltage	V <sub>IL</sub>	S0, S1 pins			0.8	V
Output High Voltage	V <sub>OH</sub>	I <sub>OH</sub> = -12 mA	2.4			V

Parameter	Symbol	Conditions	Min.	Typ.	Max.	Units
Output Low Voltage	$V_{OL}$	$I_{OL} = 12 \text{ mA}$			0.4	V
Output High Voltage, CMOS level	$V_{OH}$	$I_{OH} = -4 \text{ mA}$	VDD-0.4			V
Operating Supply Current	IDD	No load VDD = 3.3 V		10		mA
Short Circuit Current		CLK output		$\pm 50$		mA
Input Capacitance	$C_{IN}$	S0, S1 pins		5		pF
Nominal Output Impedance				20		$\Omega$
Frequency Synthesis Error		All Clocks			0	ppm
Internal Pull-Up Resistor	$R_{PUP}$	S1, S0 pins		750		k $\Omega$

Note 1: CMOS level input. Nominal trigger point is VDD/2 for 3.3 V or 5 V operation

## AC Electrical Characteristics

VDD = 3.3 V  $\pm 5\%$ , Ambient Temperature -40 to +85° C, unless stated otherwise

Parameter	Symbol	Conditions	Min.	Typ.	Max.	Units
Input Crystal or Clock Frequency	$F_{IN}$			27		MHz
Output Clock Rise Time	$t_{OR}$	0.8 to 2.0 V, Note 1		0.7	1.5	ns
Output Clock Fall Time	$t_{OF}$	2.0 to 8.0 V, Note 1		0.7	1.5	ns
Clock Stabilization Time After Power Up					10	ms
Changing Frequency Setting					10	ms
Output Clock Duty Cycle		at VDD/2, Note 1	40		60	%
Maximum Absolute Jitter, short term	$t_{ja}$	Deviation from mean		$\pm 150$		ps

Note 1: Measured with 15 pF load.

## Thermal Characteristics

Parameter	Symbol	Conditions	Min.	Typ.	Max.	Units
Thermal Resistance Junction to Ambient	$\theta_{JA}$	Still air		150		$^{\circ}\text{C/W}$
	$\theta_{JA}$	1 m/s air flow		140		$^{\circ}\text{C/W}$
	$\theta_{JA}$	3 m/s air flow		120		$^{\circ}\text{C/W}$
Thermal Resistance Junction to Case	$\theta_{JC}$			40		$^{\circ}\text{C/W}$

### Marking Diagram – MK2703BS

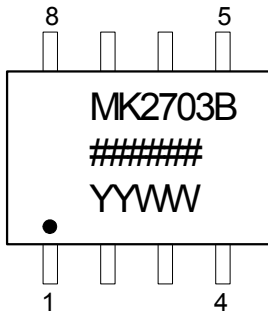

### Marking Diagram – MK2703BSI

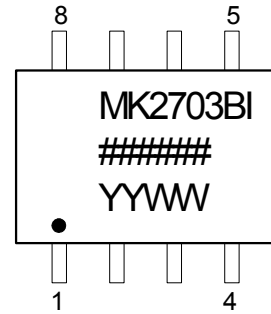

### Marking Diagram – MK2703BSLF

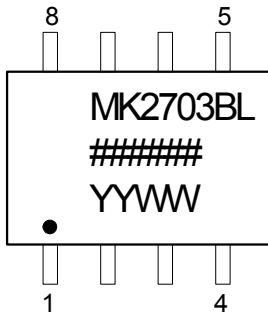

### Marking Diagram – MK2703BSILF

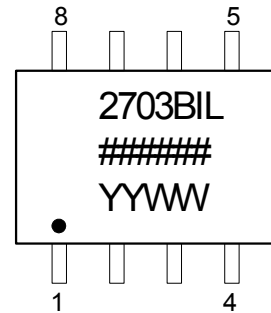

#### Notes:

1. ##### is the lot number.
2. YYWW is the last two digits of the year and the week number that the part was assembled.
3. "L" or "LF" denotes Pb (lead) free packaging.
4. "I" denotes industrial temperature range.
5. Bottom marking: (origin). Origin = country of origin if not USA.

## Package Outline and Package Dimensions (8-pin SOIC, 150 Mil. Narrow Body)

Package dimensions are kept current with JEDEC Publication No. 95

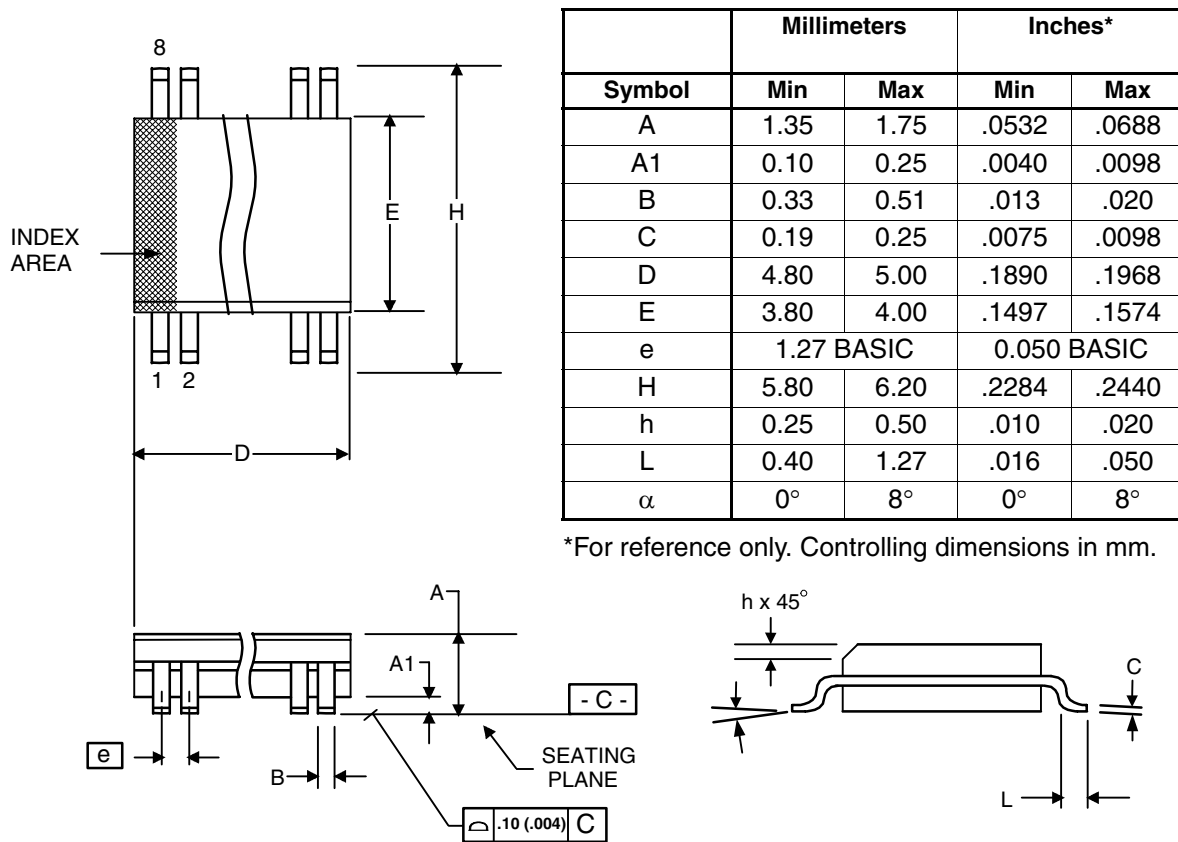

## Ordering Information

Part / Order Number	Marking	Shipping Packaging	Package	Temperature
MK2703BS	see page 5	Tubes	8-pin SOIC	0 to +70° C
MK2703BSTR		Tape and Reel	8-pin SOIC	0 to +70° C
MK2703BSI		Tubes	8-pin SOIC	-40 to +85° C
MK2703BSITR		Tape and Reel	8-pin SOIC	-40 to +85° C
MK2703BSLF		Tubes	8-pin SOIC	0 to +70° C
MK2703BSLFTR		Tape and Reel	8-pin SOIC	0 to +70° C
MK2703BSILF		Tubes	8-pin SOIC	-40 to +85° C
MK2703BSILFTR		Tape and Reel	8-pin SOIC	-40 to +85° C

**Parts that are ordered with a "LF" suffix to the part number are the Pb-Free configuration and are RoHS compliant.**

While the information presented herein has been checked for both accuracy and reliability, Integrated Circuit Systems (ICS) assumes no responsibility for either its use or for the infringement of any patents or other rights of third parties, which would result from its use. No other circuits, patents, or licenses are implied. This product is intended for use in normal commercial applications. Any other applications such as those requiring extended temperature range, high reliability, or other extraordinary environmental requirements are not recommended without additional processing by ICS. ICS reserves the right to change any circuitry or specifications without notice. ICS does not authorize or warrant any ICS product for use in life support devices or critical medical instruments.

Innovate with IDT and accelerate your future networks. Contact:

**www.IDT.com**

**For Sales**

800-345-7015  
408-284-8200  
Fax: 408-284-2775

**For Tech Support**

<product line email>  
<product line phone>

---

**Corporate Headquarters**

Integrated Device Technology, Inc.  
6024 Silver Creek Valley Road  
San Jose, CA 95138  
United States  
800 345 7015  
+408 284 8200 (outside U.S.)

**Asia Pacific and Japan**

Integrated Device Technology  
Singapore (1997) Pte. Ltd.  
Reg. No. 199707558G  
435 Orchard Road  
#20-03 Wisma Atria  
Singapore 238877  
+65 6 887 5505

**Europe**

IDT Europe, Limited  
Prime House  
Barnett Wood Lane  
Leatherhead, Surrey  
United Kingdom KT22 7DE  
+44 1372 363 339



www.IDT.com